

御納入先

殿

殿

# 製品納入仕様書

工事件名  
(現場名)

貴注文番号等

品名

埋設管標示ピン「キャツアイ」

型式 / 仕様

別紙図に記す形状寸法、および各種任意の標示内容に基づく

ご受領日	
ご受領印	

出図年月日

整理番号等

販売

〒530-0053 大阪市北区末広町2番38号



株式  
会社

石井マーク

電話：06-6314-1410 FAX：06-6314-2502

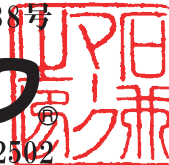

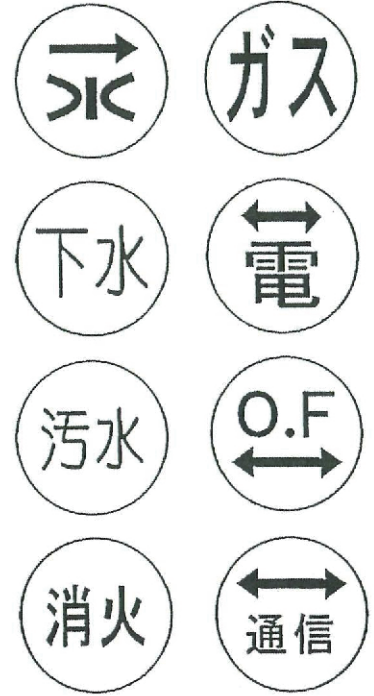
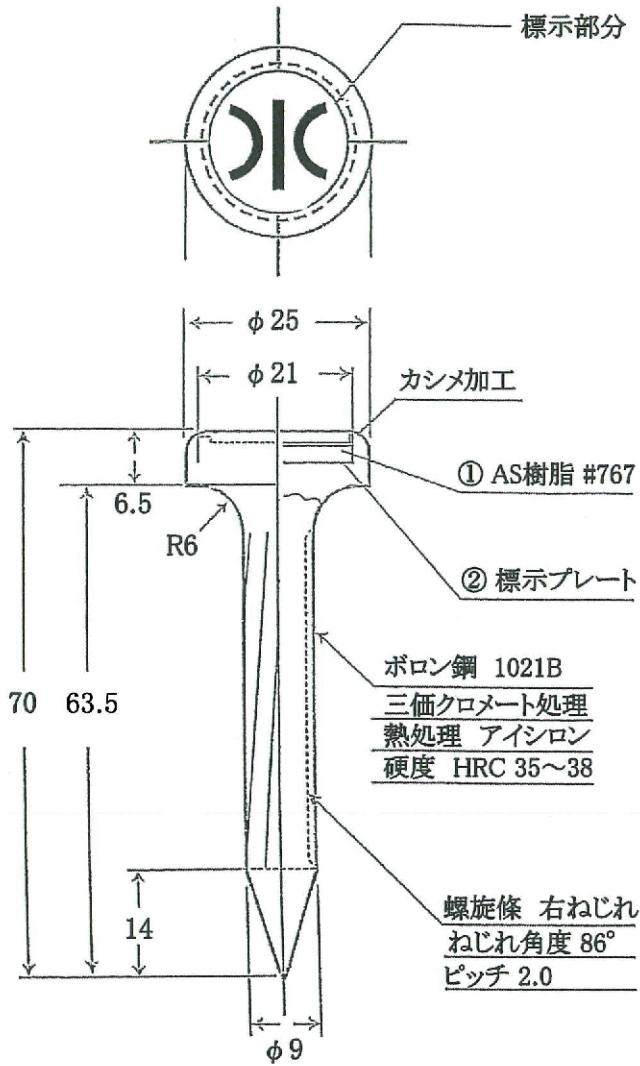

( 単位 : mm )

① AS樹脂 #767

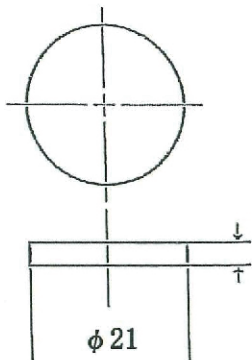



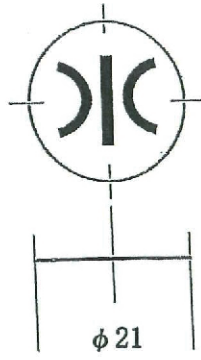









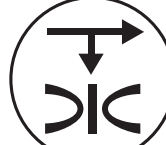











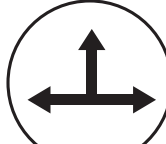

② 標示プレート

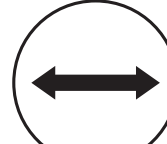
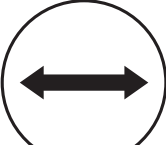

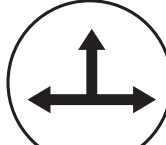
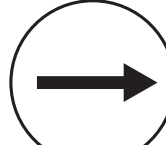
部 品 名		埋 設 管 標 示 ピ ン		
部 番		部 品 名		
材 料		個 数		
検 図	設 計	製 図	写 図	製 図 日 付
				2016 . 02 . 10

株式会社 イリエ 製作所

# 標示内容の例を示す図

下地	文字・矢印	(水道・給水用)
青地	黒	     W-1      W-2      W-3      W-4      W-5
黄地	黒	(ガス用)      G-1Y      G-2Y      G-3Y      G-4Y      G-5Y
赤地	黒	(消火配管用)      S-1      S-2      S-3      S-4      S-5
白地	赤色	(電力用)      E-1A      E-2      E-3      E-4      E-5A
白地	黄色	(通信用)      IT-1      IT-2      IT-3      IT-4      IT-5
茶地	黒色	(油送管ほか油用)      O-1      O-2      O-3      O-4      O-5

(図は表記品番の一例であり、必要に応じてその他の色や文字・矢印を用いて任意に記すものとする。)